

JPS

For sewage and wastewater treatment



Motor

- 2-14 pole
- Insulation Class : F
- 3Phase/220V/380V/440V
- 3000-429rpm
- Line Start(0.75KW-15KW)
- Star Delta(15KW-110KW)
- Standard Power : 22KW-190KW

Pump

- Impeller : Enclosed type
- Material
 - Impeller : GC200/SSC13
 - Casing : GC200/SSC13
 - Suction Cover : GC200/SSC13
 - Shaft : SCM440/STS410
- Connecting method
 - Flange Coupling/Hose Coupling/ Automatic Discharge connector

Application

- Transfer solid at sewage, wastewater treatment plant
- Effluent transfer from waste & sewage water treatment plant
- Fountain, decorative waterfall
- Supply factory with industrial water



Features

- Minimizing stopping-up of foreign materials
- Multi-pole applicable according to water quantity
- Increase durability with 4 pole motor
- Including the electric motor protector
- Perfect watertight with double mechanical seal

Performance curve

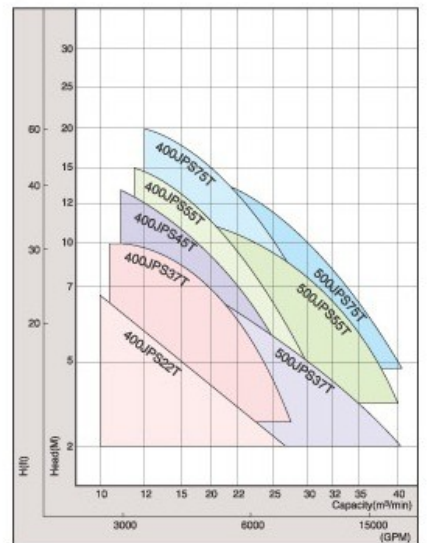
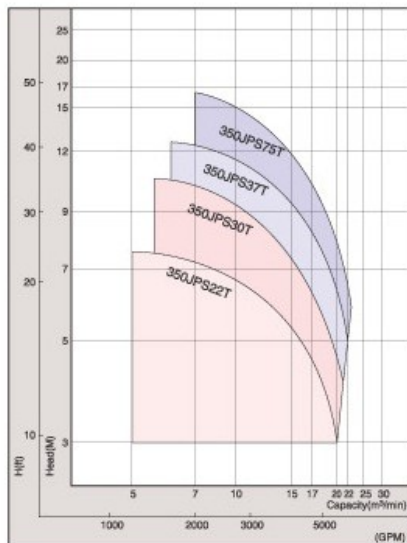
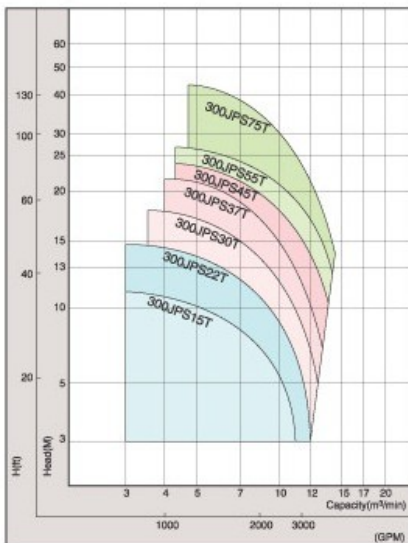
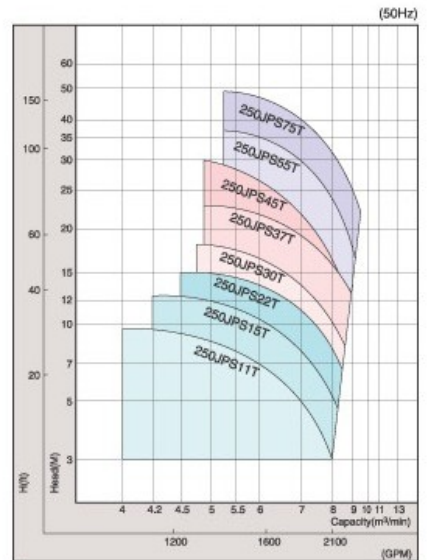
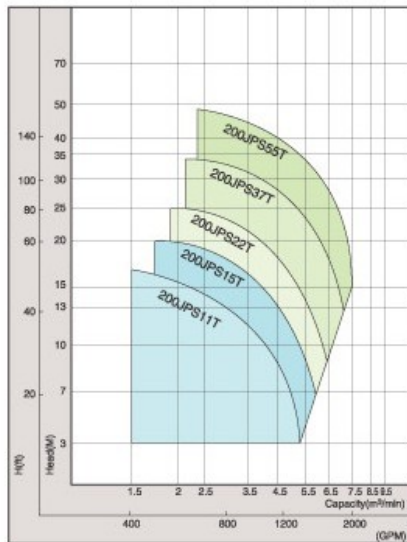
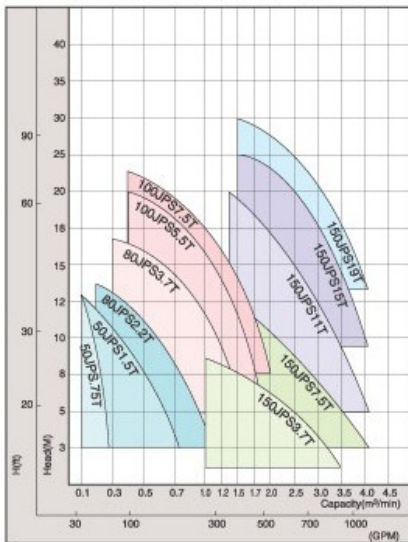

● Drawing

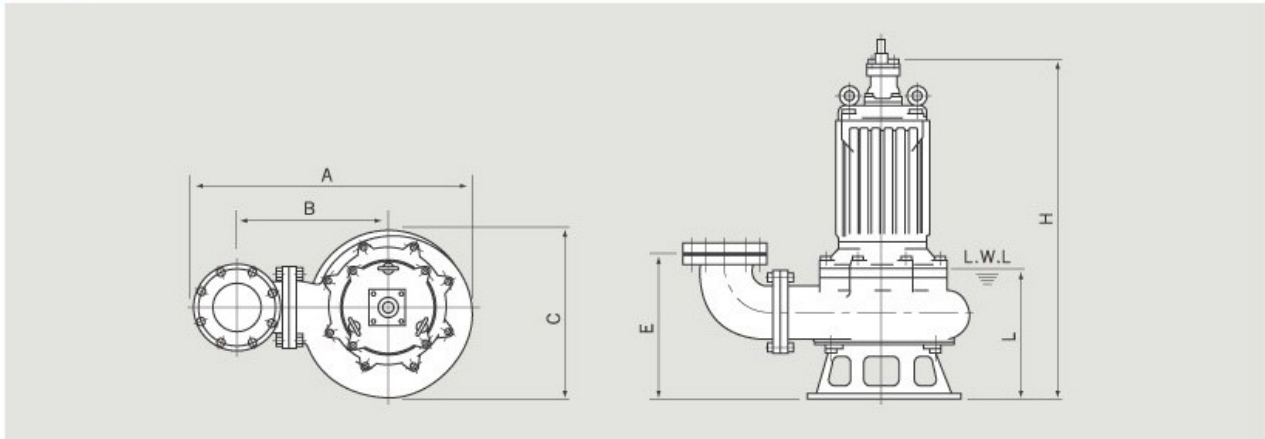

● Standard model

Discharge (mm)	MODEL	Output (Kw)	Head (M)	Capacity (lit/min)	A (mm)	B (mm)	C (mm)	E (mm)	H (mm)	L (mm)	Weight (Kg)
50	50JPS0.75T	0.75	10	0.2	350	250	170	200	430	200	40
	50JPS1.5T	1.5	8	0.5	480	270	210	220	400	250	50
80	80JPS2.2T	2.2	10	0.6	620	330	340	310	640	350	100
	80JPS3.7T	3.7	15	0.6	700	390	400	310	650	350	120
100	100JPS5.5T	5.5	16	1.0	710	400	410	315	690	400	250
	100JPS7.5T	7.5	18	1.0	710	400	410	315	690	400	260
150	150JPS3.7T	3.7	5	2.5	780	420	410	450	750	410	270
	150JPS7.5T	7.5	9	2.5	910	540	460	420	970	450	280
	150JPS11T	11	15	2.5	910	540	460	420	970	450	330
	150JPS15T	15	20	2.5	910	540	460	420	970	450	340
	150JPS19T	19	25	2.5	1100	680	570	500	1240	490	550
200	200JPS11T	11	9	4.5	940	580	355	430	860	500	350
	200JPS15T	15	13	4.5	940	580	355	430	860	500	360
	200JPS22T	22	18	4.5	965	580	450	475	1090	550	600
	200JPS30T	30	23	4.5	965	580	450	475	1090	550	640
	200JPS37T	37	28	4.5	975	580	465	475	1145	600	670
	200JPS55T	55	40	4.5	975	580	465	475	1145	600	1280
250	250JPS11T	11	7	3	1010	690	450	570	1050	550	520
	250JPS15T	15	9	3.5	1010	690	450	570	1050	550	530
	250JPS19T	19	10	5.5	1510	690	700	660	1035	550	650
	250JPS22T	22	11.5	7	965	580	450	675	1090	550	790
	250JPS30T	30	15	6.5	965	580	450	675	1090	550	950
	250JPS37T	37	19	7	975	580	465	675	1145	600	1090
	250JPS45T	45	26	6	975	580	465	675	1145	600	1150
	250JPS55T	55	30	7	975	580	465	675	1145	600	1320

Discharge (mm)	MODEL	Output (Kw)	Head (M)	Capacity (lit/min)	A (mm)	B (mm)	C (mm)	E (mm)	H (mm)	L (mm)	Weight (Kg)
250	250JPS75T	75	40	7	975	580	465	675	1145	600	1400
	300JPS15T	15	6.5	9	1460	870	720	595	1090	550	690
300	300JPS22T	22	9	10	1460	870	720	595	1200	700	940
	300JPS30T	30	11.5	10	1460	870	720	595	1200	700	1030
	300JPS37T	37	15	10	1460	870	720	595	1260	750	1120
	300JPS45T	45	18	10	1460	870	720	595	1260	750	1320
	300JPS55T	55	21	10	1460	870	720	595	1260	750	1550
	300JPS75T	75	30	10	1460	870	720	595	1260	750	1840
	300JPS90T	90	45	10	1460	870	720	595	1540	900	1950
350	350JPS22T	22	5.5	15	1900	1150	940	970	1580	900	1550
	350JPS30T	30	7.5	15	1900	1150	940	970	1580	900	1610
	350JPS37T	37	9.5	15	1900	1150	940	970	1580	900	1720
	350JPS45T	45	12	15	1900	1150	940	970	1580	900	1780
400	350JPS55T	55	17	15	1460	870	720	595	1390	800	1900
	400JPS22T	22	4	20	2100	1350	1150	1270	1700	1000	1790
	400JPS37T	37	7	20	2100	1350	1150	1270	1700	1000	2070
	400JPS45T	45	9	20	2100	1350	1150	1270	1700	1000	2240
400	400JPS55T	55	11	20	2100	1350	1150	1270	1700	1000	2400
	400JPS65T	65	13	20	2060	1310	940	1000	1610	950	2470
	400JPS75T	75	15	20	2060	1310	940	1000	1610	950	2470
	400JPS110T	110	18	20	2200	1310	950	1010	2000	1250	2700
	400JPS280T	280	48	20	2500	1525	1000	1670	2300	1300	3000
	500JPS37T	37	5	30	2460	1470	1050	1000	1620	950	2070
500	500JPS55T	55	7.5	30	2460	1470	1050	1000	1620	950	2300
	500JPS75T	75	10	30	2460	1470	1050	1000	1620	950	2760